



GERGONNE

The Adhesive Solution

PRODUCT PORTFOLIO

AUTOMOTIVE AND INDUSTRY MARKETS

Press START to discover our solutions

START

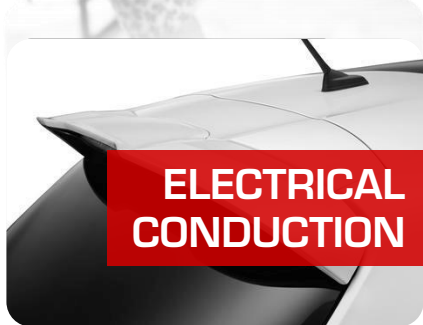
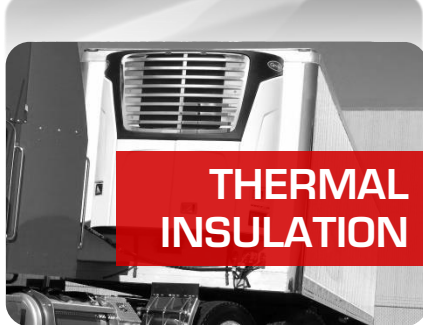
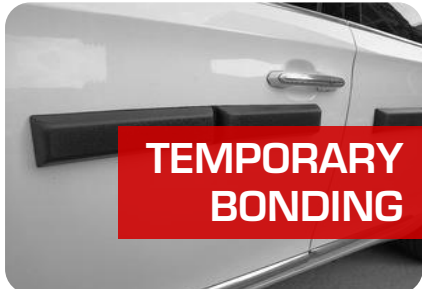

The Adhesive Solution



BADGE-MOUNTING



**SENSOR SUPPORT
FIXATION**



**LCD DISPLAY
COMPONENTS
MOUNTING**

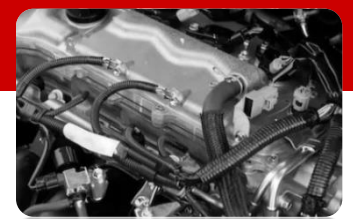

CAR HOSES

PERMANENT BONDING

**PRE-FIXATION OF
ELECTRICAL BOX**



CAMERA COVER



**TACTILE STUDS
FIXATION**

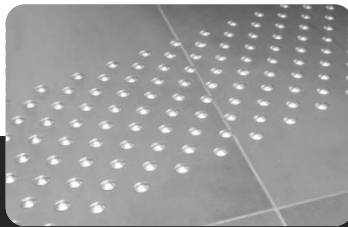

CABLE DUCT



POS DISPLAYS



PERMANENT BONDING



BADGE-MOUNTING

Material: Gergonne double-sided foam tape

Note: more than one out of three cars manufactured in Europe use Gergonne tape for this function



PERMANENT BONDING

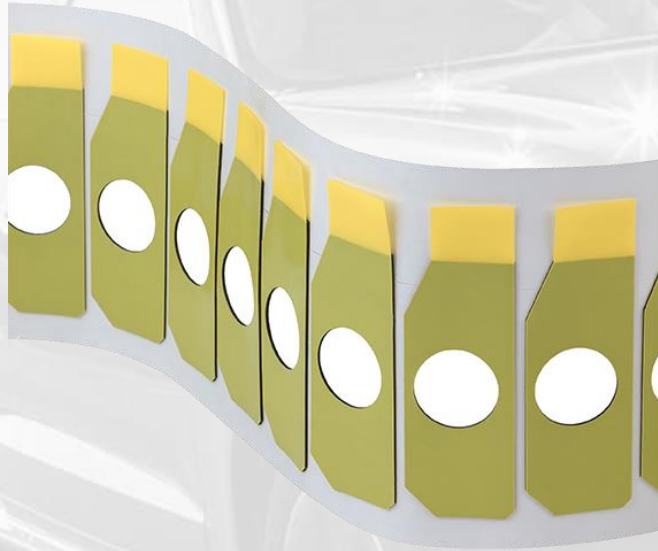

SENSOR SUPPORT FIXATION

Material: Acrylic foam tape



PERMANENT BONDING

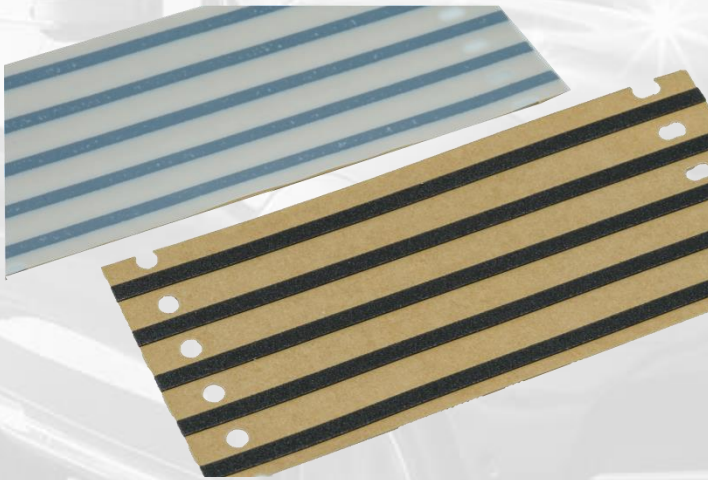

MOUNTING AND CUSHIONING OF LCD DISPLAY COMPONENTS

Material: Gergonne double sided foam tape





CAR HOSES

Material: specifically designed Gergonne adhesive tape

Note: high temperature resistance (engine compartment)



PERMANENT BONDING



PRE-FIXATION OF ELECTRICAL BOX

Material: Gergonne adhesive tape



PERMANENT BONDING

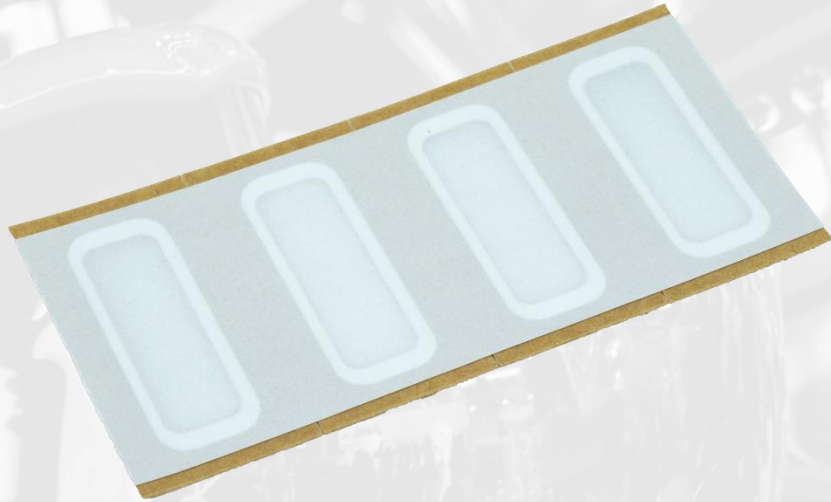

CAMERA COVER FOR LAPTOPS

Material: Gergonne double sided PET tape



PERMANENT BONDING



TACTILE STUDS

Material: Gergonne double sided foam tape

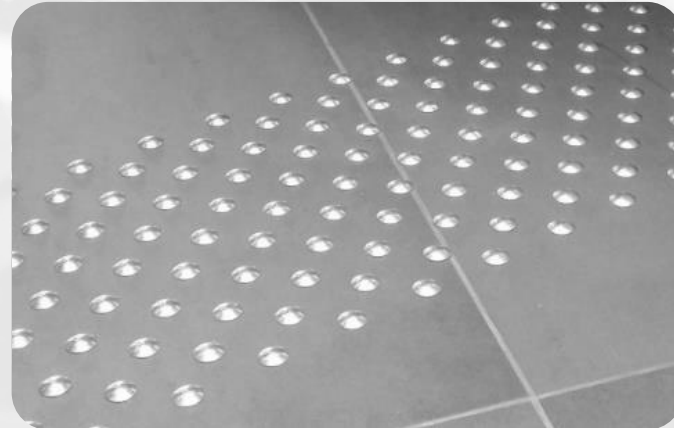

PERMANENT BONDING



CABLE DUCT FOR ELECTRICAL CABLES

Material: Gergonne double sided foam tape



PERMANENT BONDING

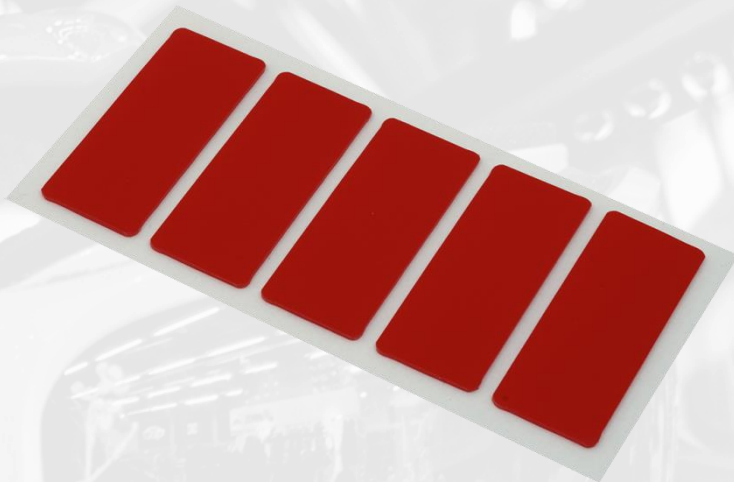

INVISIBLE MOUNTING FOR POINT OF SALE DISPLAYS

Material: Gergonne acrylic foam tape



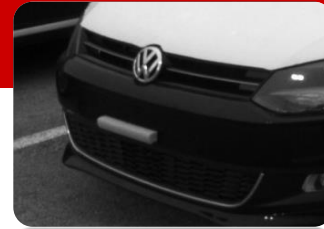

**IMPACT PROTECTION
FOAM**



**PATCH FOR TRUNK
HATCHBACK**

TEMPORARY BONDING

**RESEALABLE
BAGS CLOSURE**



**LAYING FLOOR
COVERINGS**



**ABRASIVE FOR MICRO
EXFOLIATION**





IMPACT PROTECTION FOAM

Material: Non cross-linked PE foam + Gergonne double sided tape (one side removable)



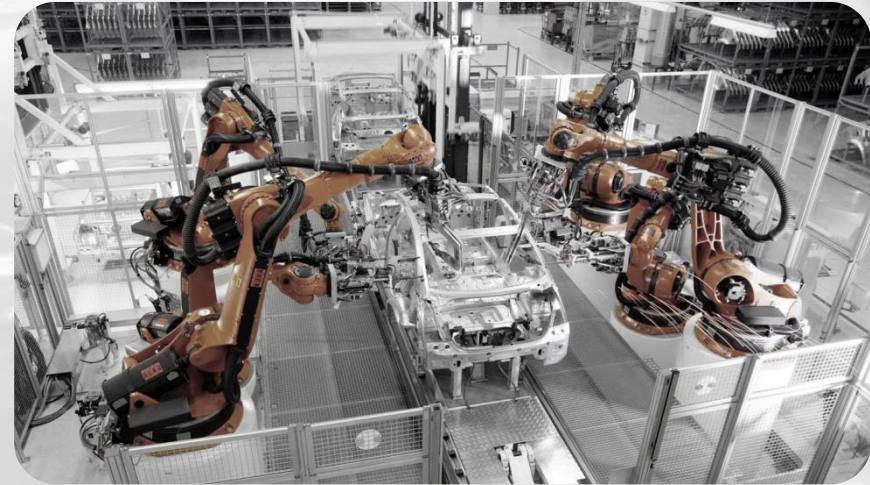

PATCH FOR TRUNK HATCHBACK GLUING PROCESS

Project: Volvo

Material: PET film + Gergonne adhesive tape

Note: protection patch used in the gluing process of the trunk hatchback



TEMPORARY BONDING

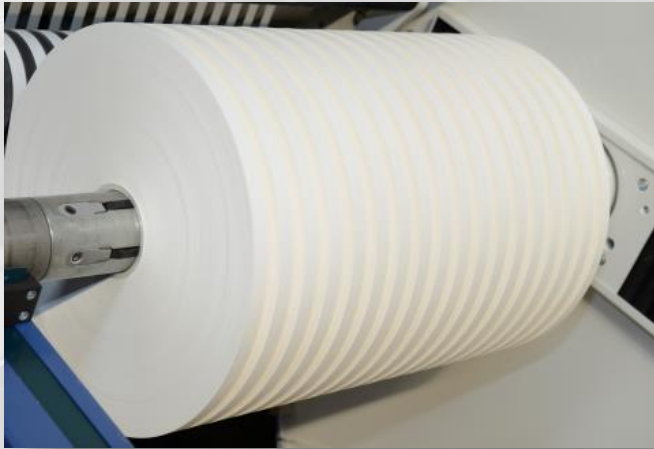

ADHESIVE FOR PACKAGING CLOSURE FOR THE FOOD MARKET (E.G.: CHEESE)

Material: Gergonne double-sided polyester adhesive tapes



TEMPORARY BONDING



ADHESIVE FOR LAYING FLOOR COVERINGS

Material: Gergonne thin scrim adhesive tapes



TEMPORARY BONDING

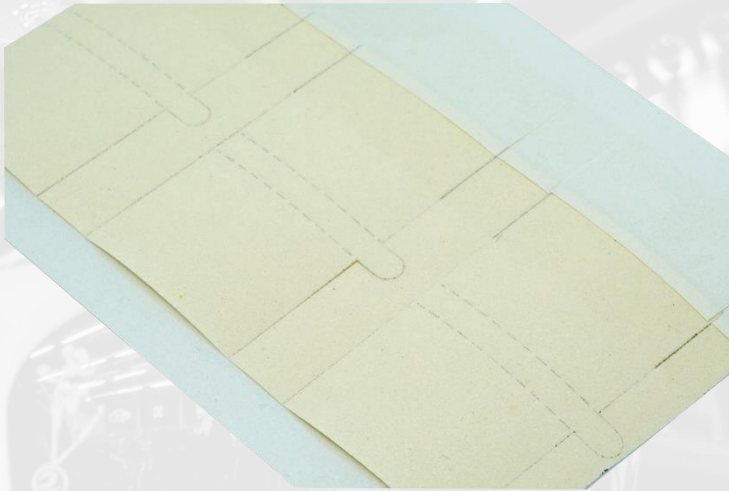

ABRASIVE FOR FOOT MICRO EXFOLIATION

Material: Gergonne adhesive tape and customer abrasive material





**DISPLAY
PROTECTION**



**CONTROL KEY BUTTON
PROTECTION**



**CAR INTERIOR
PROTECTION**



**STEERING WHEEL
CABLE PROTECTION**

SURFACE PROTECTION

**PROTECTION
FILM**



**GERGOPROTEC
RANGE**



SURFACE PROTECTION



TRANSPARENT PROTECTIVE FOIL FOR AUTOMOTIVE SCREEN DISPLAY

Material: Gergonne removable adhesive tape



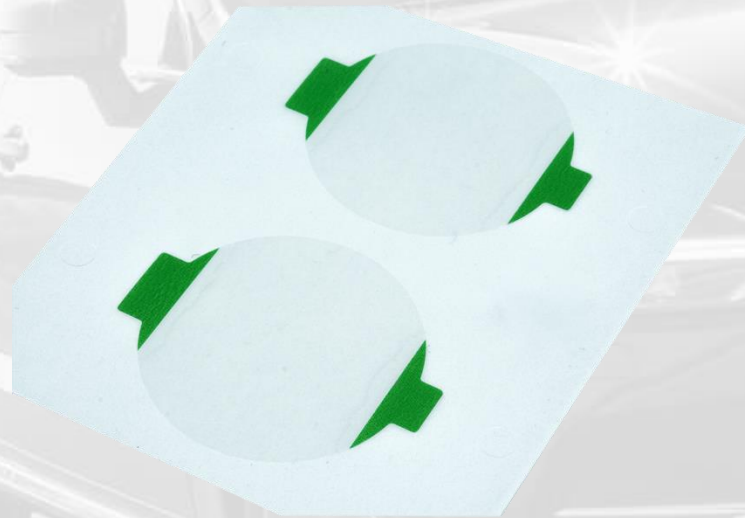

FILM FOR CONTROL KEY BUTTON PROTECTION

Material: Gergonne single sided PET adhesive tape (removable)





PROTECTION FILM FOR CAR INTERIOR COMPONENTS

Material: Gergonne single sided PET adhesive tape (removable)





PROTECTION OF STEERING WHEEL CONTROL CABLE

Material: 100µm technical film

Note: long length, narrow web



SURFACE PROTECTION

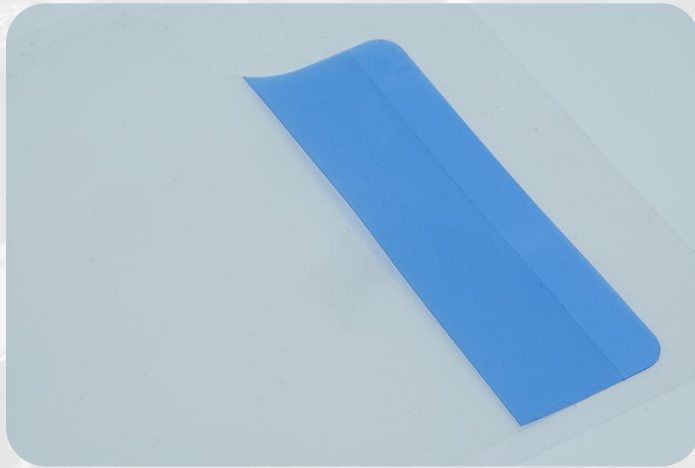

PROTECTION FILM FOR ELECTRONIC DEVICES

Material: Gergonne adhesive protection film



SURFACE PROTECTION



GERGOPROTEC RANGE

Material: Gergonne single sided foam & felt adhesive tapes

Note: homologated by Alstom for train construction





WATER SEAL



**SEAL OF DOOR
MECHANISM**



**CAR BODYWORK
OBTURATOR**



**LICENSE PLATE
LAMP**

AIR/DUST/WATER PROOFING

**GASKETS FOR
JOINERY PROFILES**



**GASKET FOR DOUBLE
SCREEN SKI MASK**



**AIR-TIGHT EYELETS
FOR ELECTRIC CABLES**

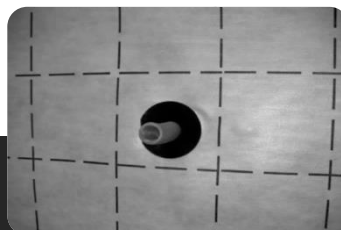

**GASKET FOR AIR-
CONDITIONING SYSTEM**



AIR/DUST/WATER PROOFING



BUMPER SEALS

Project: Renault
Material: EPDM cellular rubber
+ Gergonne adhesive tape

THIRD BREAK LIGHT GASKET

Project: Ford Mondeo
Material: EPDM cellular rubber +
Gergonne adhesive tape

REAR LIGHT SEALING

Project: VW Passat CC
Material: EPDM cellular rubber +
Gergonne adhesive tape



AIR/DUST/WATER PROOFING

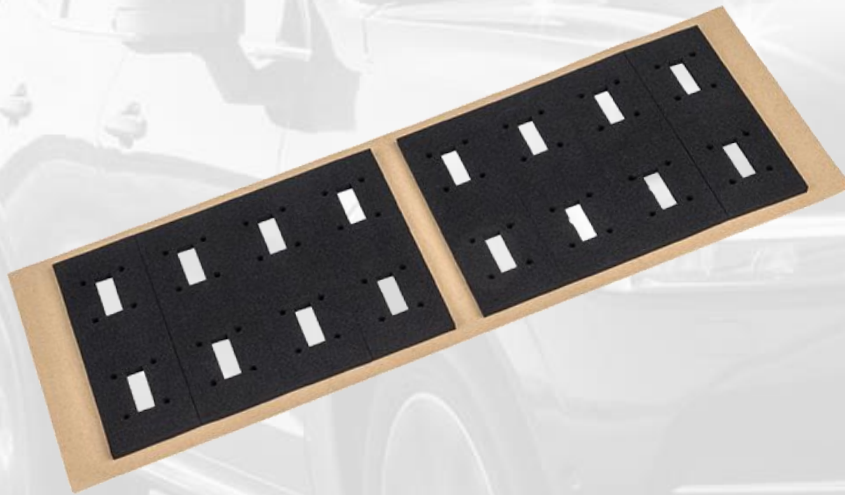

SEAL OF DOOR MECHANISM

Material: EPDM compact rubber + Gergonne adhesive tape



AIR/DUST/WATER PROOFING



CAR BODYWORK OBTURATOR

Material: PE foam and Gergonne adhesive tape



AIR/DUST/WATER PROOFING



LICENSE PLATE LAMP

Material: EPDM cellular rubber and Gergonne adhesive tape



AIR/DUST/WATER PROOFING



SEALING GASKETS FOR JOINERY PROFILES

Material: Silicone foam + Gergonne adhesive tape



AIR/DUST/WATER PROOFING



SEALING GASKET FOR DOUBLE SCREEN SKI MASK

Material: Gergonne double sided foam tape



AIR/DUST/WATER PROOFING

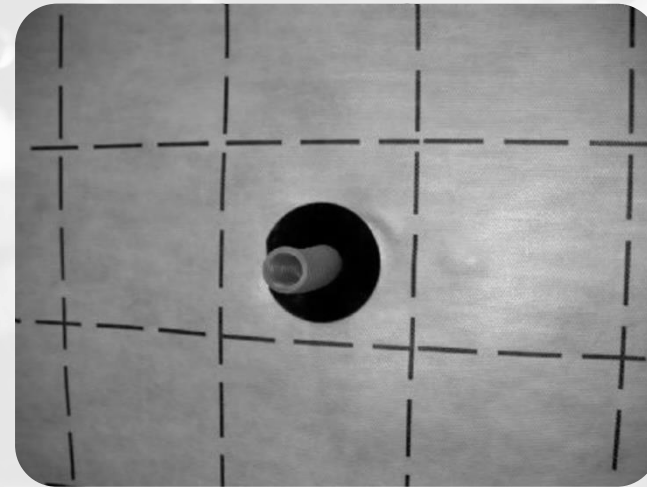
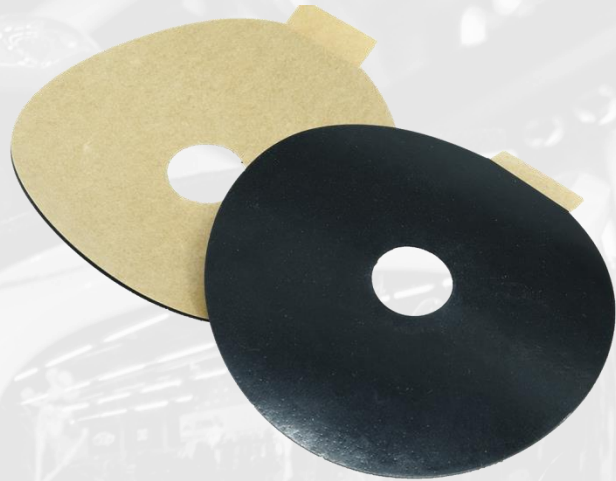

AIR-TIGHT EYELETS FOR ELECTRIC CABLES

Material: Compact rubber + Gergonne adhesive tape



AIR/DUST/WATER PROOFING



SEALING GASKET FOR AIR-CONDITIONING SYSTEM

Material: PU foam + Gergonne adhesive tape





**STEERING-WHEEL
CASING**



**CAR CEILING
MICROPHONE**

COVERING / DECORATION

**SCREW
COVER**



**BUTTON COVER
FOR DESK CHAIR**



**CAP COVER FOR
PERFUME BOTTLE**



**PATCH FOR
MILITARY EQUIPMENT**



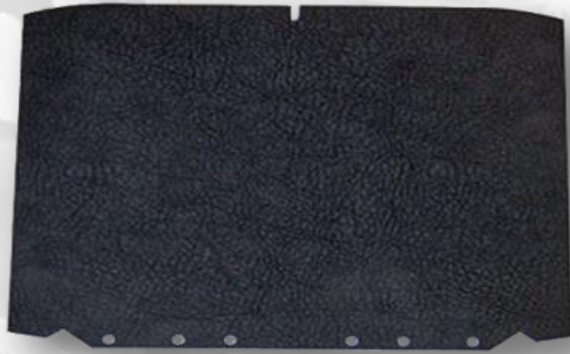

STEERING-WHEEL CASING

Project: VW Caddy
Material: Artificial leather





CAR CEILING MICROPHONE

Material: Non-woven felt + Gergonne adhesive tape





SCREW COVERS

Material: PVC + Gergonne adhesive tape

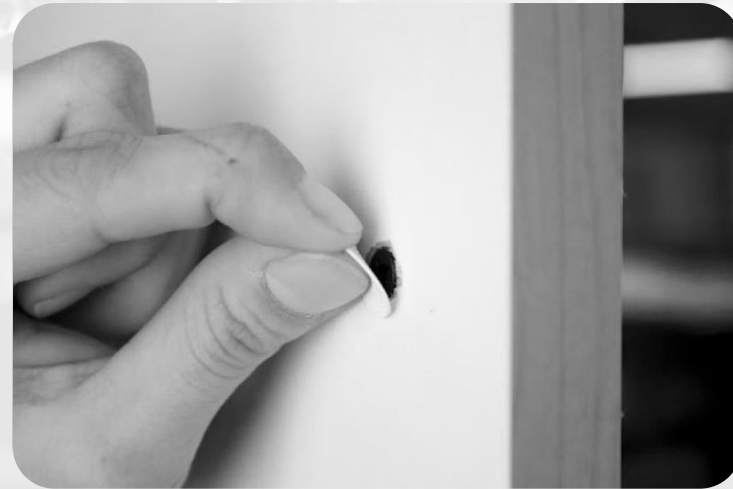



BUTTON COVER FOR DESK CHAIR

Material: PVC + Gergonne adhesive tape



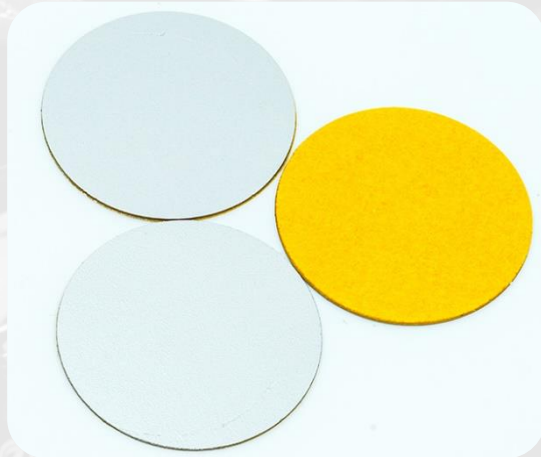

CAP COVER FOR PERFUME BOTTLE

Material: PVC + Gergonne adhesive tape





PATCH FOR MILITARY EQUIPMENT

Material: Fabric and foam + Gergonne adhesive tape



THERMAL INSULATION

**FOAM FOR STEEL
ROOF CLADDING**

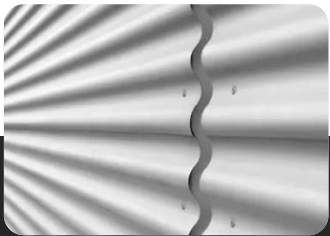

**FOAM FOR
REFRIGERATION UNITS**



**AIR-CONDITIONING
SYSTEM**



THERMAL INSULATION

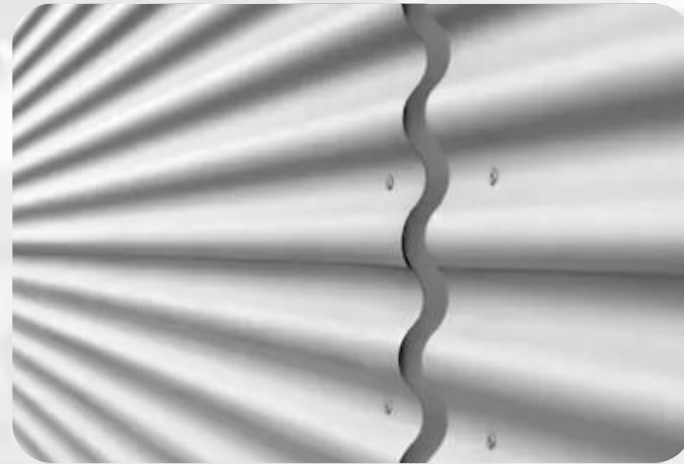
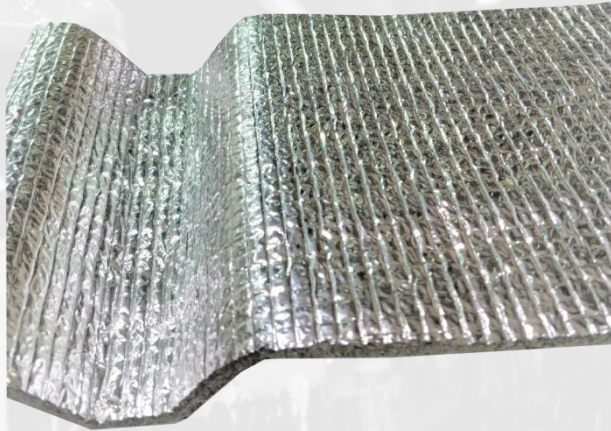

INSULATION FOAM FOR STEEL ROOF CLADDING

Material: Aluminium and foam + Gergonne transfer tape



THERMAL INSULATION



INSULATION FOAM FOR REFRIGERATION UNITS

Material: EPDM cellular rubber + Gergonne adhesive tape



THERMAL INSULATION

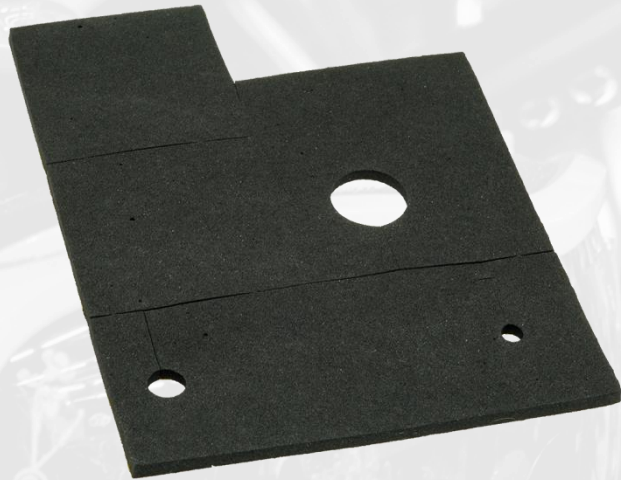

INSULATION FOAM FOR AIR-CONDITIONING SYSTEM

Material: PE foam + Gergonne adhesive tape





**CAR ENGINE
COMPARTMENT**

HEATSHIELD

**GAS
BOILER**





CAR ENGINE COMPARTMENT

Material: Aluminium + Gergonne adhesive tape



HEATSHIELD



HEAT SHIELD FOR GAS BOILER

Material: Aluminium + Gergonne adhesive tape



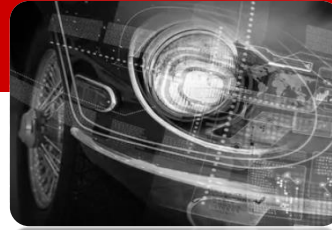

**CAR LIGHTING
COMPONENTS**



**ELECTRONIC
DISPLAYS**



**ELECTRIC VEHICLE
BATTERY**

THERMAL DISSIPATION

**LCD TV
SCREEN**

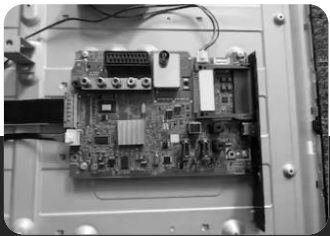

**DISHWASHER
MACHINE**



THERMAL DISSIPATION



INTERIOR & EXTERIOR CAR LIGHTING COMPONENTS

Material: GERGOTIM range





ELECTRONIC DISPLAYS

Material: GERGOTIM range



THERMAL DISSIPATION



THERMAL MANAGEMENT OF ELECTRIC VEHICLE BATTERY

Material: GERGOTIM range



THERMAL DISSIPATION



LCD TV SCREEN

Material: GERGOTIM range

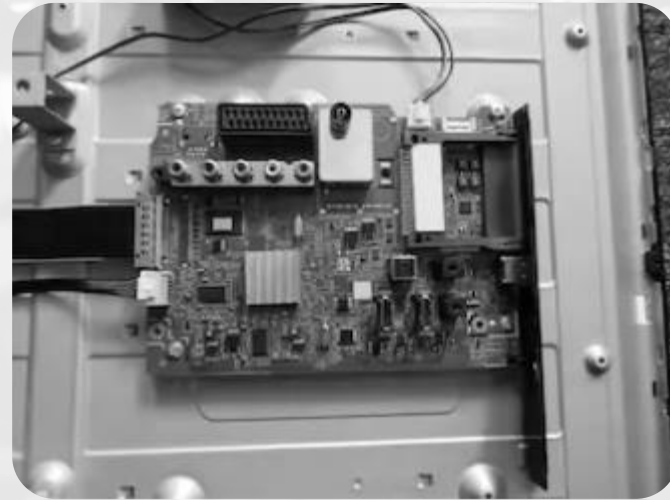

THERMAL DISSIPATION

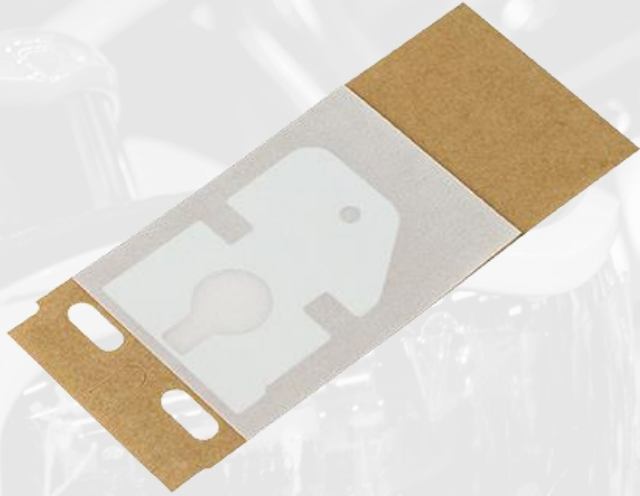

DISHWASHER MACHINE

Material: GERGOTIM range





**ON BOARD
CHARGER**



CONDENSATOR

ELECTRICAL INSULATION

**ELECTRONIC
CIRCUIT BOARD**

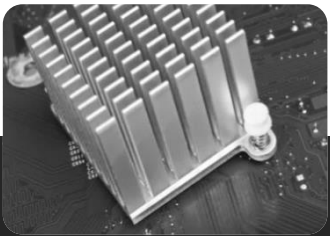

**AA
BATTERY**



ELECTRICAL INSULATION

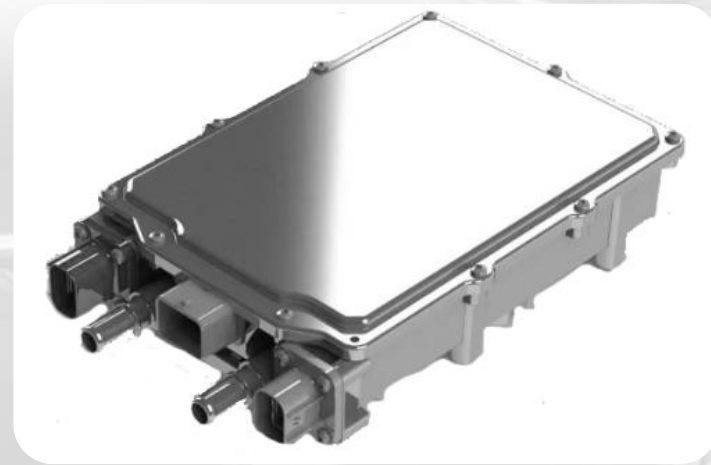

ON BOARD CHARGER FOR ELECTRIC VEHICLES

Material: Flame retardant PP film





CONDENSATOR (CAR BATTERY)

Material: PET + Gergonne adhesive tape



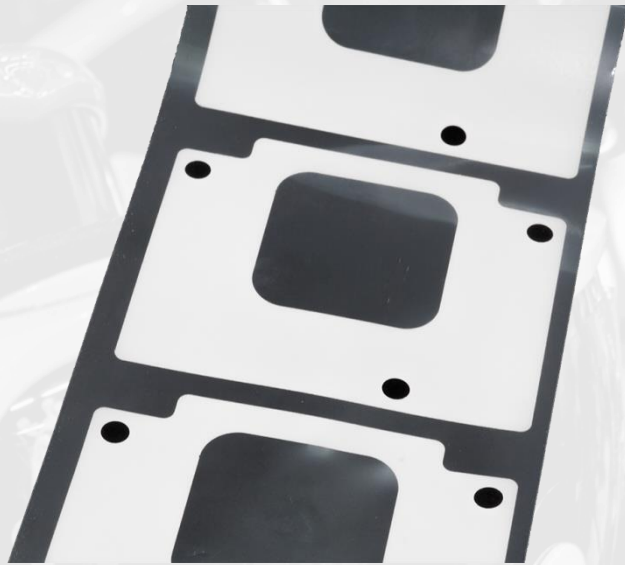

ELECTRONIC CIRCUIT BOARD

Material: GERGOTIM range



ELECTRICAL INSULATION

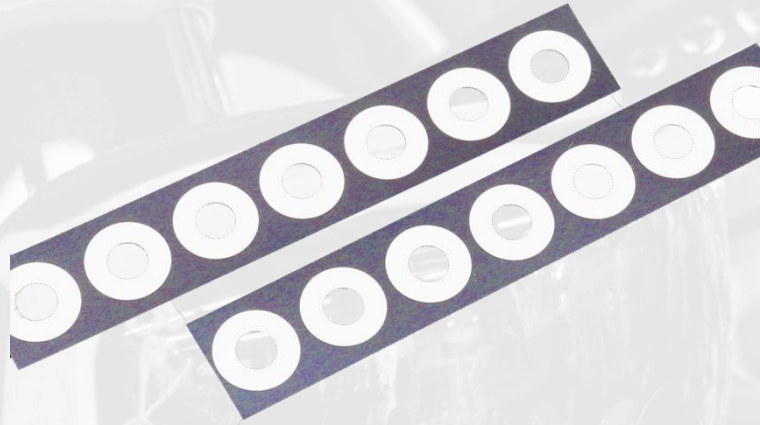

AA BATTERY

Material: PET + Gergonne adhesive tape





**ANTENNA
FILM**

ELECTRICAL CONDUCTION





ANTENNA FILM – RADIO WAVES RECEPTION

Project: Peugeot 3008 II

Material: Aluminium + Gergonne adhesive tape





BRAKE SHIMS



CAR CONSOLE



**FELTS FOR
CAR INTERIOR**

IMPACT NOISE REDUCTION AND DAMPING

**CHAIR
GLIDES**

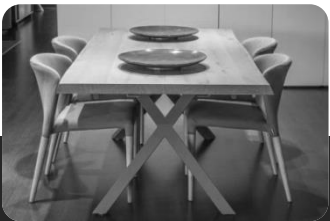

**ANTI-SHOCK
ADHESIVE PAD**

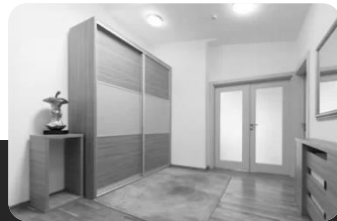

IMPACT NOISE REDUCTION AND DAMPING



BRAKE SHIMS

Material: Gergonne transfer adhesive tape



IMPACT NOISE REDUCTION AND DAMPING



CAR CONSOLE

Material: Felt + Gergonne adhesive tape



IMPACT NOISE REDUCTION AND DAMPING



FELTS FOR CAR INTERIOR

Material: Felt + Gergonne adhesive tape



IMPACT NOISE REDUCTION AND DAMPING



CHAIR GLIDES

Material: Felt + Gergonne adhesive tape



IMPACT NOISE REDUCTION AND DAMPING

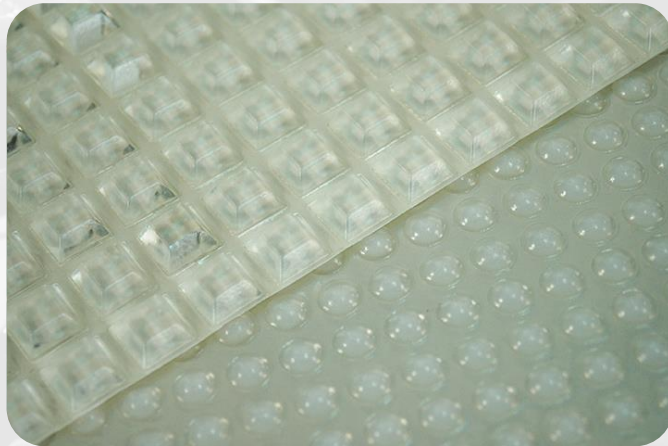

ANTI-SHOCK ADHESIVE PAD

Material: PU + Gergonne adhesive tape





**CAR DOOR
INSULATION**



CAR TRUNK

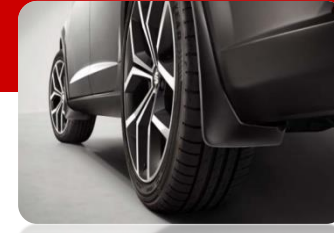

**REAR WHEEL
ARCH**



FRONT PANEL

SOUND INSULATION

**ELECTRIC
HEATER**



**HVAC
SYSTEM**





DOOR SOUND INSULATION

Project: C4 Picasso

Material: Agglomerated felt + Gergonne adhesive tape





CAR TRUNK

Material: Agglomerated felt + Gergonne adhesive tape



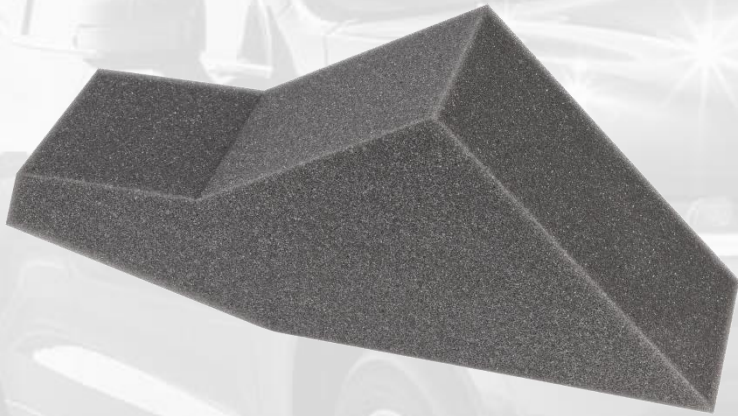

REAR WHEEL ARCH

Project: SEAT (SE372)
Material: PU foam



SOUND INSULATION

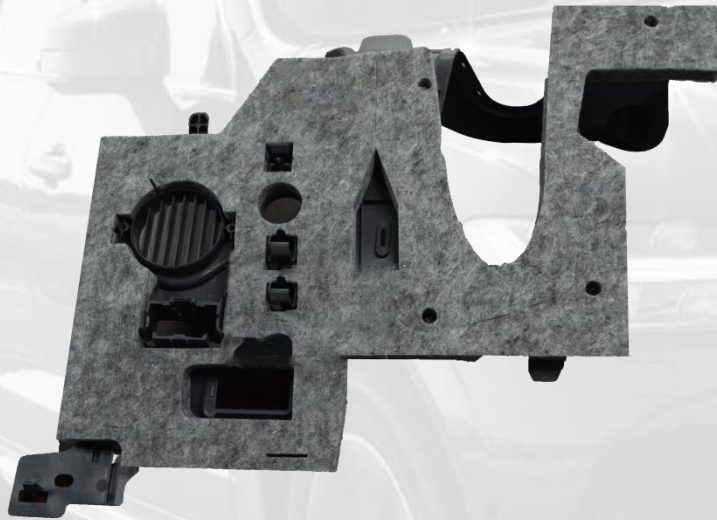

FRONT PANEL

Project: Audi Q5
Material: Agglomerated felt



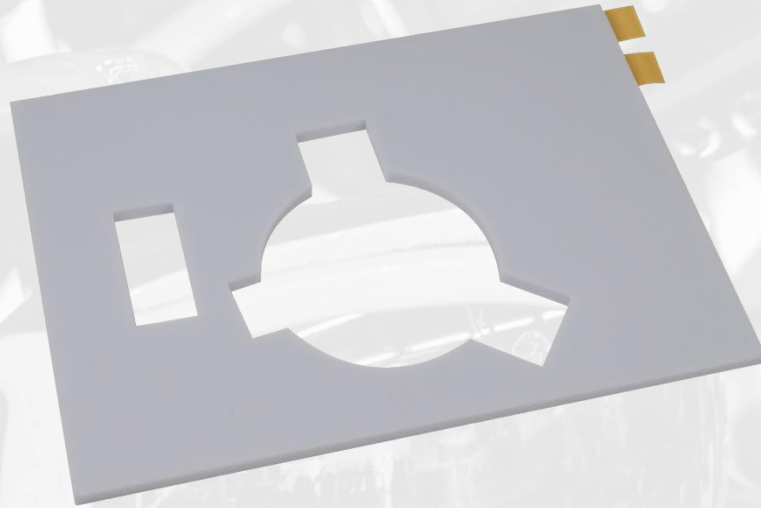

INSULATION AND SOUNDPROOFING FOAM FOR ELECTRIC HEATER

Material: Melamine foam + Gergonne adhesive tape



SOUND INSULATION

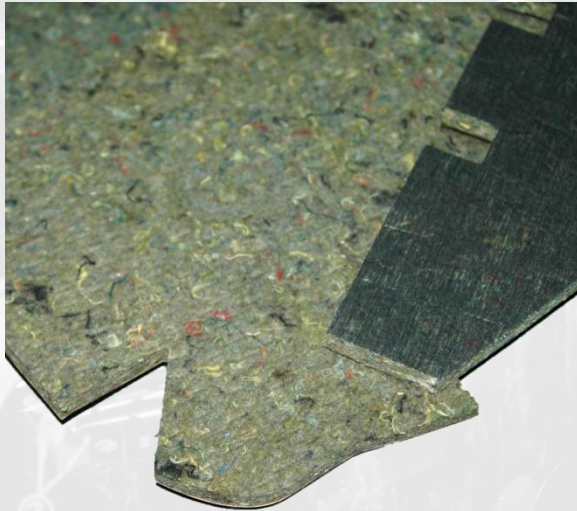

SOUND INSULATION FOR HVAC SYSTEM

Material: Agglomerated felt + Gergonne adhesive tape





**FRONT
HEADLAMPS**



REARVIEW CAMERA



WIPER MOTOR

VENTS AND PRESSURE COMPENSATION

**MEDICAL ELECTRONIC
HOUSING**



**INDUSTRIAL
OUTDOOR LIGHTING**



VENTS AND PRESSURE COMPENSATION



FRONT HEADLAMPS

Material: GERGOVENT range – Venting membrane



VENTS AND PRESSURE COMPENSATION



REARVIEW CAMERA

Material: GERGOVENT range – Venting membrane



VENTS AND PRESSURE COMPENSATION

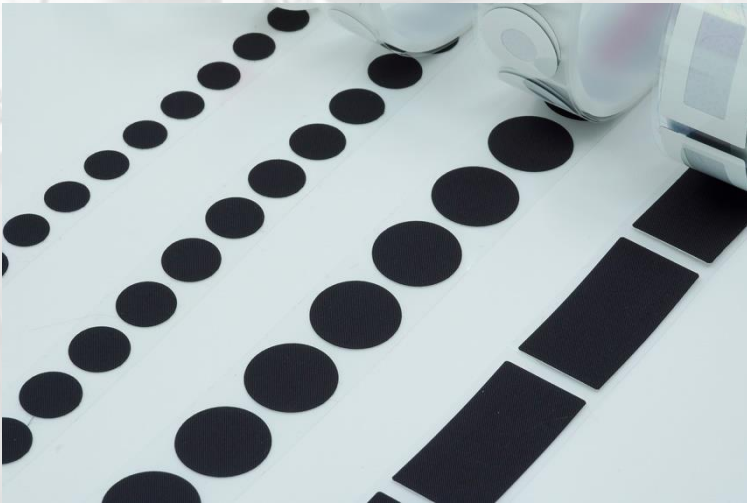

WIPER MOTOR

Material: GERGOVENT range – Venting membrane



VENTS AND PRESSURE COMPENSATION



MEDICAL ELECTRONIC HOUSING

Material: GERGOVENT range – Venting membrane



VENTS AND PRESSURE COMPENSATION

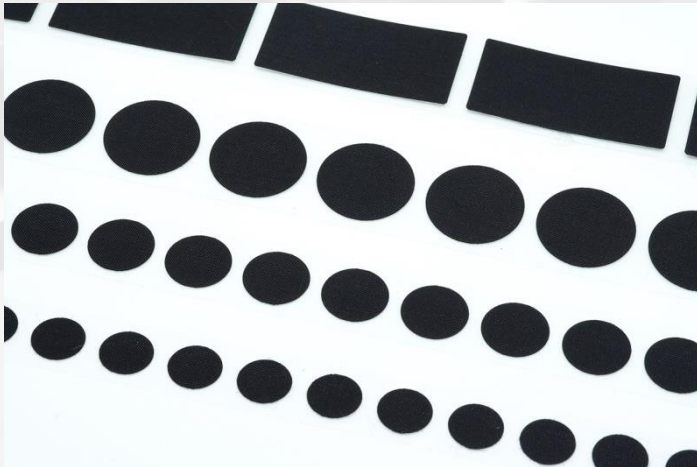

INDUSTRIAL OUTDOOR LIGHTING

Material: GERGOVENT range – Venting membrane





**CAR
LOUDSPEAKER**

FILTRATION

**PHONE
LOUDSPEAKER**



EARPHONES





CAR LOUDSPEAKER FILTER

Material: Acoustic cloth + Gergonne adhesive tape





FILTER FOR PHONE LOUDSPEAKER

Material: Acoustic cloth + Gergonne adhesive tape





EARPHONES FILTER

Material: Acoustic cloth + Gergonne adhesive tape



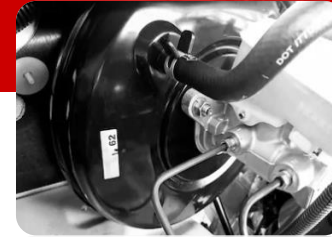

**BRAKING
BOOSTER**



**ANTI-CRUSH
PADS**

SPACING

**IDENTIFICATION
LABELS**



**DAMPING
WEDGE**





GASKET BETWEEN BRAKING BOOSTER & CAR FIREWALL

Material: Gergonne double sided foam tape



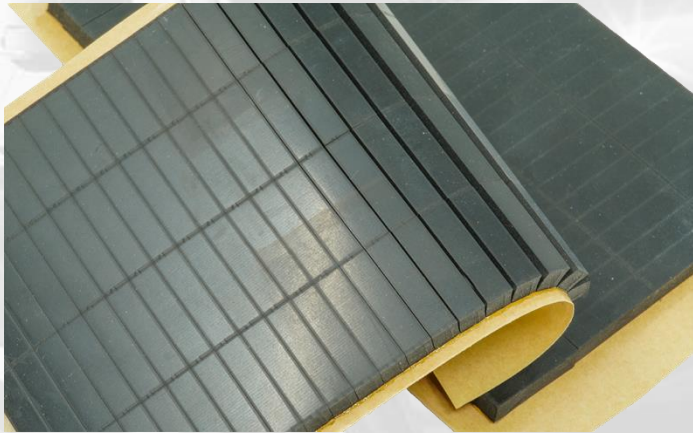

ANTI-CRUSH PAD FOR CAR OPENING ROOF

Material: Compact rubber EPDM + Gergonne adhesive tape



SPACING

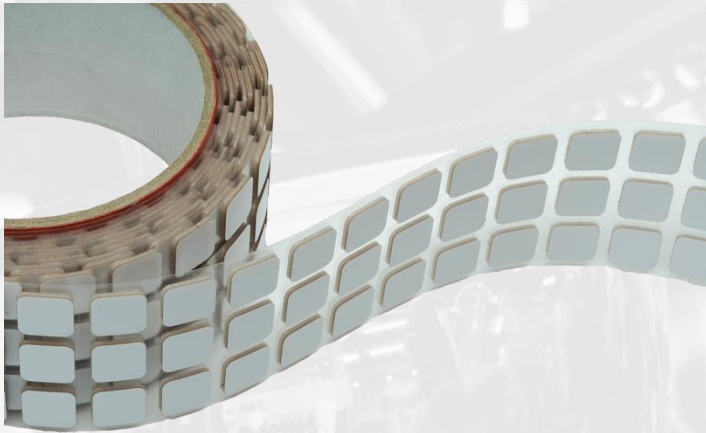

IDENTIFICATION AND PROTECTION LABELS

Material: Acrylic foam tape and high temperature resistance printable film



SPACING



DAMPING WEDGE FOR CRUDE STEEL STORAGE

Material: Material made from recycled tyres





GLOVE BOX



HEADREST



**TRUCK INTERIOR
STORAGE
COMPARTMENT**

TOUCH FEEL AND COMFORT

**CHILDREN'S
SLED**



**SLALOM LEG
GUARD**



**SKI BOOTS
INSOLES**



TOUCH FEEL AND COMFORT



GLOVE BOX

Material: Carpet + Gergonne adhesive tape



TOUCH FEEL AND COMFORT



HEADREST

Material: PU foam + Gergonne adhesive tape



TOUCH FEEL AND COMFORT



TRUCK INTERIOR STORAGE COMPARTMENT

Material: Carpet + Gergonne adhesive tape



TOUCH FEEL AND COMFORT



CHILDREN'S SLED

Material: PE foam + Gergonne double sided adhesive tape



TOUCH FEEL AND COMFORT



PROTECTION FOAM FOR SLALOM LEG GUARD

Material: EPDM cellular rubber + Gergonne adhesive tape



TOUCH FEEL AND COMFORT



COMFORT FOAM FOR INSOLES

Material: PE foam + Gergonne double sided adhesive tape





VEHICLE SEATS



**ROOF OPENING
CAR**

SLIDING PADS

**SKI
BINDING**



**BIKE PEDAL
HOOD**



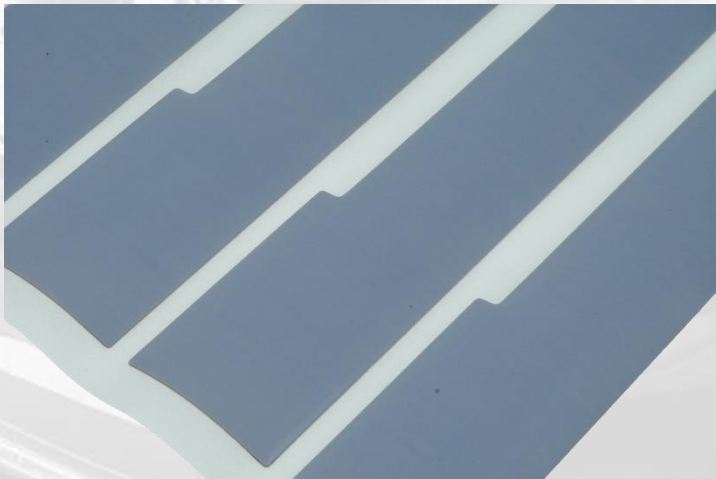

PADS FOR VEHICLE SEATS

Material: PTFE + Gergonne adhesive tape





PADS FOR SLIDING ROOF CAR

Material: Polyester non woven and Gergonne double sided adhesive tape



SLIDING PADS



SKI BINDING

Material: Acrylic foam tape and PTFE



SLIDING PADS



LOWER HOOD OF THE BIKE PEDAL

Material: Gergonne double sided adhesive tape and PTFE





**CAR STORAGE
COMPARTMENT**

NON-SLIP PADS

COOKTOP



**PALLET
LOADING**



**HOME
APPLIANCE**



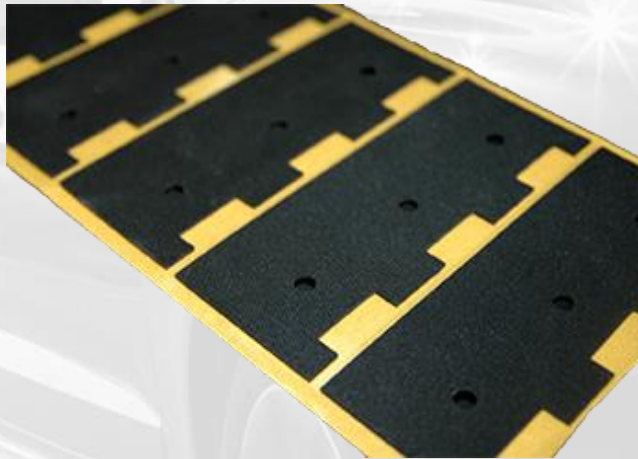

CAR STORAGE COMPARTMENT

Material: Compact rubber EPDM + Gergonne adhesive tape



NON-SLIP PADS

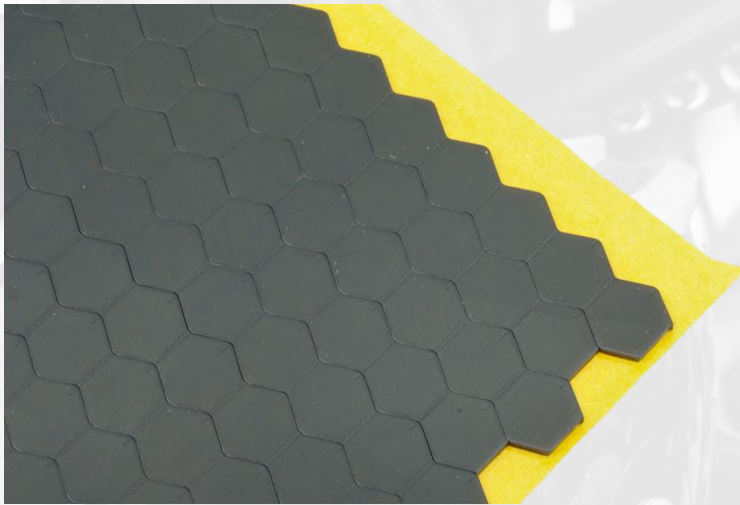

COOKTOP

Material: Compact rubber and Gergonne adhesive tape



NON-SLIP PADS



NON-SLIP PADS FOR THE PALLETS IN THE TRUCK

Material: Material made from recycled tyres



NON-SLIP PADS

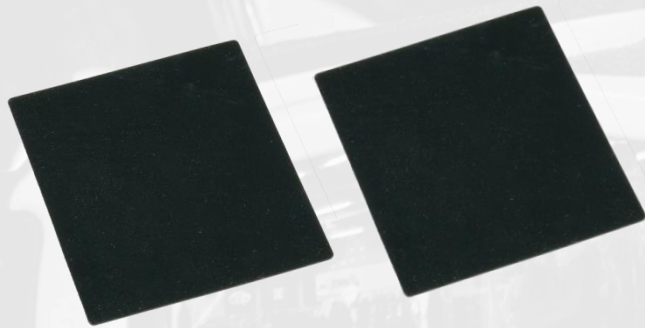

PADS FOR DOMESTIC ARTICLES / HOME APPLIANCES

Material: PU + Gergonne adhesive tape

